

模具定位器 Mould Positioner

尺寸 (mm) / Dimensions (mm)

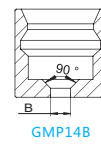

货号(PN)	型号(Model)	A	B	D	E	F	G	H	I	J	K	最大锁持力	重量(Weight)
8.Y00408	GMP14A	38	14	M12*1	-	12	5	4	Ø14	Ø11	M5	90N	62g
8.Y00088	GMP20A	46	25	M17*1	19	18	10	9	Ø20	Ø15.5	G1/8	190N	78g
8.Y00089	GMP30A	75	38	M27*1	28	27	11	10	Ø30	Ø25.5	G1/8	280N	303g

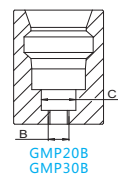
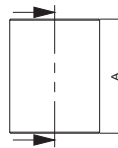
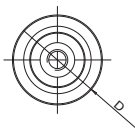

货号(PN)	型号(Model)	A	B	C	D	精度(Precision)	重量(Weight)
7.Y00968	GMP14B	15	M4沉头	-	15.5h7	±0.015	46g
7.Y00726	GMP20B	33	M6(或M5沉头)	10	26h7	±0.015	87g
7.Y00789	GMP30B	43.5	M8(或M6沉头)	11	40h7	±0.015	264g

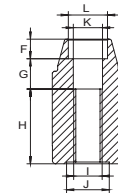
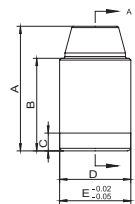

货号(PN)	型号(Model)	A	B	C	D	E	F	G	H	I	J	K	L	重量(Weight)
7.Y00894	GLU20A	35	26	5	Ø19.92	Ø20	5.50	8.50	21	M8	Ø12	Ø8.20	Ø11	61g

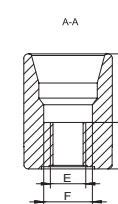
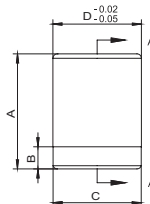

货号(PN)	型号(Model)	A	B	C	D	E	F	G	H	重量(Weight)
7.Y00895	GLU20B	26	5	Ø19.92	Ø20	M8	Ø11	15.50	10.50	42g

运用实例 / Application example

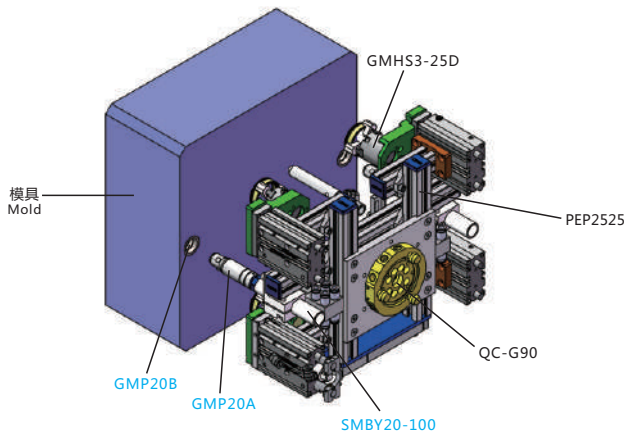

型材 / SUS Tube

支架模组
Stents Module

快换
Quick Changer

夹组件
Grip Module

气动剪刀
Air Nipper

真空组件
Vacuum Module

附件
Accessory Components

拨指选件 Finger Gripper Options

型材
钢管
Profile
SUS Tube

支架
模组
Stents
Module

快换
Quick
Changer

夹具
组件
Grip
Module

气动
剪刀
Air
Nipper

真空
组件
Vacuum
Module

附件
Accessory
Components

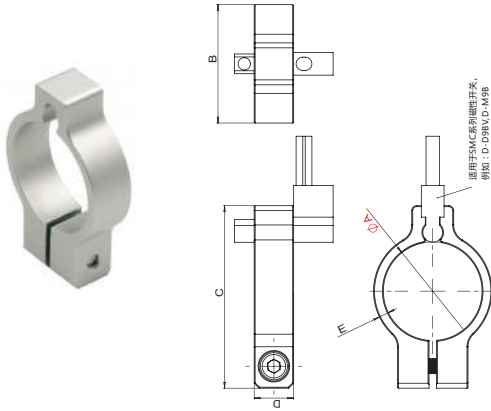

货号(PN)	7.Y00786	7.Y00787	7.Y00788
型号(Model)	GS-14	GS-20	GS-30
A(mm)	Ø14	Ø20	Ø30
B(mm)	18	24	34
C(mm)	30	37	47
D(mm)	8	8	8
E(mm)	2	2	2
重量(Weight)	14g	17g	25g

可选的磁传感器 Optional Magnetic Sensors

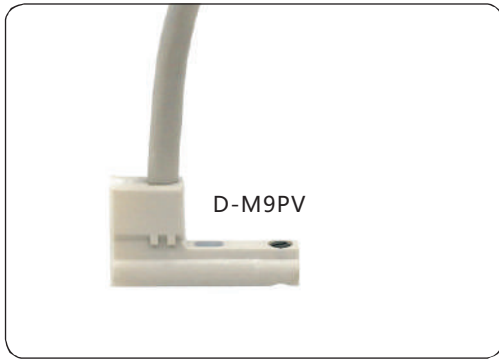

D-M9P • M9PV

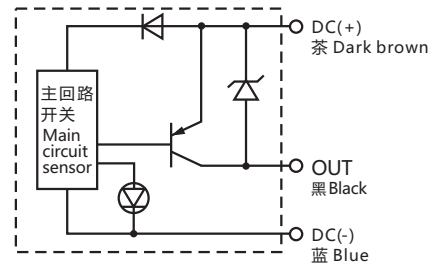

货号(PN)	型号(Model)	开关类型	L(mm)
1.Y00296	D-M9PV	PNP	电缆0.5m/0.5m cable
1.Y02964	D-M9PVL		电缆3.0m/3m cable